



garage doors
classic style
INTELLIGENT DESIGN

Price List

November 2010





Price List

November 2010

garage doors
classic style
INTELLIGENT DESIGN

This price list covers the complete range of Legbud garage doors, options and accessories. Prices shown exclude VAT and delivery. Prices in **bold green** denote stock sizes finished in white (RAL9010) - please call for availability of other sizes and colours.

General notes:

Delivery to site POA.

Multiple doors and remote locations POA.

All illustrations represent a 2134mm wide X 2134mm high door (7'0"x7'0") and all sizes are listed width x height.

Up and over doors are supplied with MAXIPLUS retractable operating gear and a steel frame in a matching colour. All doors include a galvanized threshold. Timber doors are supplied with a brown frame.

The position of lock handles may vary dependent on door size.

Open for infil doors have a weight limit of 7.5kg/m².

STEEL STANDARD SIZES

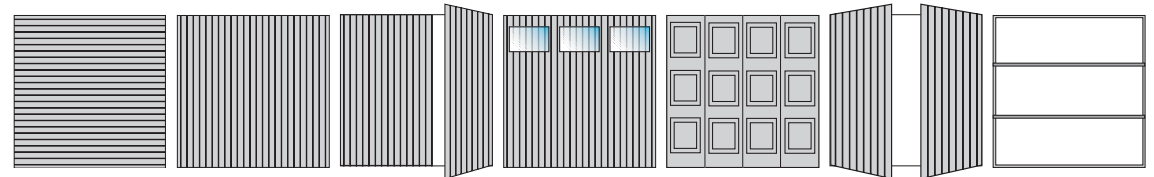

ORDER CODE	OVERALL FRAME SIZE mm*	HORIZONTAL	VERTICAL	VERTICAL SMARTPASS	VERTICAL WINDOWS	GEORGIAN	VERTICAL SIDE HINGED	OPEN FOR INFIL
6660	2101 x 1880	£445	£510	-	£730	-	-	£400
6663	2101 x 1957	£445	£510	-	£730	-	-	£400
6664	2101 x 1981	£445	£510	-	£730	£620	-	£400
6666	2101 x 2031	£420	£485	£745	£705	£590	£615	£400
6670	2101 x 2190	£420	£485	£745	£705	£600	£615	£400
61064	2205 x 1981	£430	£480	-	£700	£595	-	£400
61066	2205 x 2031	£440	£480	£760	£700	£595	£615	£400
61070	2205 x 2190	£455	£490	£760	£710	£640	£615	£400
7060	2254 x 1880	£455	£520	-	£740	-	-	£400
7063	2254 x 1957	£455	£520	-	£740	-	-	£400
7064	2254 x 1981	£435	£485	-	£705	£595	-	£400
7066	2254 x 2031	£385	£405	£710	£690	£595	£615	£400
7070	2254 x 2190	£440	£460	£710	£710	£630	£615	£400
7076	2254 x 2338	£565	£605	-	£825	-	-	£450
7164	2290 x 1981	£475	£520	-	£740	£630	-	£450
7166	2290 x 2031	£480	£520	£735	£740	£635	£615	£450
7170	2290 x 2190	£490	£545	£735	£765	£685	£615	£450
7176	2290 x 2336	£625	£660	-	£880	£815	-	£450
7364	2330 x 1981	£475	£505	-	£725	£665	-	£450
7366	2330 x 2031	£475	£510	-	£730	£665	-	£450
7370	2330 x 2031	£485	£515	-	£735	£670	-	£450
7564	2379 x 1981	£500	£535	-	£755	£700	-	£450
7566	2379 x 2031	£475	£515	£760	£735	£665	£625	£450
7570	2379 x 2190	£540	£580	£760	£800	£765	£625	£450
7576	2379 x 2338	£670	£660	-	£880	£930	-	£450
7664	2406 x 1981	£475	£525	-	£745	£665	-	£450
7666	2406 x 2031	£475	£525	£760	£745	£665	£625	£450
7670	2406 x 2190	£540	£580	£760	£800	£765	£625	£450
7676	2406 x 2336	£675	£660	-	£880	-	-	£450
8064	2558 x 1981	£545	£625	-	£845	£790	-	£450
8066	2558 x 2031	£545	£625	£845	£845	£790	£670	£450
8070	2558 x 2190	£560	£645	£845	£865	£820	£670	£450
8076	2558 x 2338	£660	£745	-	£965	-	-	£500
8666	2711 x 2031	£635	£715	-	£935	£815	-	£500
8670	2711 x 2190	£650	£775	-	£895	£875	-	£500
8676	2711 x 2336	£725	£855	-	£1,075	-	-	£500
9066	2864 x 2031	£760	£790	£945	£1,165	£890	£815	£500
9070	2864 x 2190	£800	£830	£1,170	£1,205	£930	£815	£500
1066	3170 x 2031	£820	£850	£1,045	£1,225	£950	£890	£500
1070	3170 x 2190	£825	£855	£1,045	£1,230	£955	£890	£500
1166	3474 x 2031	£835	£865	£1,160	£1,240	£965	£1,025	£850
1170	3474 x 2190	£840	£870	£1,160	£1,245	£970	£1,025	£850
1266	3779 x 2031	£850	£880	£1,200	£1,255	£980	£1,070	£850
1270	3779 x 2190	£890	£920	£1,200	£1,295	£1,020	£1,115	£850
1366	4084 x 2031	£895	£925	£1,235	£1,300	£1,025	£1,115	£850
1370	4084 x 2190	£920	£950	£1,235	£1,325	£1,050	£1,200	£850

STEEL UP & OVER, "SMARTPASS", SIDE HINGED & PERSONNEL DOORS

Doors are available in standard and made to measure sizes as shown. Prices are for white doors - RAL 9010 (Open for infil doors will be supplied in brown).

COLOURS For all others colours add the supplement shown below.

	Doors up to 9'0" wide	Doors over 9'0" wide
Brown (RAL 8017)	£20	£40
Cherry Red (RAL 3995)	£80	£125
Terracotta (RAL 8004)	£80	£125
Golden Oak*	£225	£400
Walnut*	£225	£400
Metallic Black (BTX 7700)	£80	£125
Metallic Graphite (BTX 5730)	£80	£125
Metallic Green (BTX 4702)	£80	£125
Any RAL colour - prices on application.		
*Horizontal & Vertical styles only		

INSULATION

	Doors up to 9'0" wide	Doors over 9'0" wide
Side hinged & "Smartpass"	£350	£450

OPTIONS

No Frame	Less £20
Delatching kit	£65
"Smartpass" and side hinged left hand opening	£85

VERTICAL STYLE PERSONNEL DOORS

2'6" x 6'6"	£375
2'6" x 7'0"	£400
3'0" x 6'6"	£425
3'0" x 7'0"	£475



*Frame sizes do not include any fitting tolerances - this must be allowed for if required.

STEEL MADE TO MEASURE SIZES

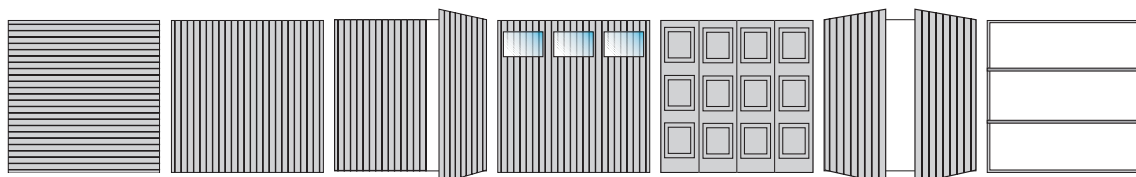

INSIDE FRAME SIZE	OVERALL FRAME SIZE mm	HORIZONTAL	VERTICAL	VERTICAL "SMARTPASS"	VERTICAL WINDOWS	GEORGIAN	VERTICAL SIDE HINGED	OPEN FOR INFIL
6'0"-6'6"	Overall Frame size =	£595	£595	£995	£835	-	£855	£450
6'6"-7'0"		£620	£620	£995	£860	£830	£855	£450
7'0"-7'6"	Inside frame width + 120mm	£655	£655	£995	£890	£890	£855	£500
7'6"-8'6"		£700	£700	£995	£950	£945	£855	£500
8'6"-9'0"	Inside frame height + 50mm	£800	£800	£995	£1,170	£955	£855	£550
9'0"-11'0"		£1,100	£1,100	£1,350	£1,475	£1,350	£1,350	£850
11'0"-13'0"		£1,200	£1,200	£1,350	£1,575	£1,450	£1,350	£950

STEEL GARAGES

Garages are built in premium polymer coated steel for outstanding corrosion protection. Prices are for galvanised finish and include the garage door.

SIZES (width x length x height front x height rear)

3000x5000x2100x1900	£1,390
3000x6000x2200x1900	£1,458

COLOURS For all others colours add the supplement shown below

White (RAL 9010)	£165
Brown (RAL 8017)	£165
Cherry Red (RAL 3995)	£200
Terracotta (RAL 8004)	£200
Metallic Black (BTX 7700)	£200
Metallic Graphite (BTX 5730)	£200
Metallic Green (BTX 4702)	£200

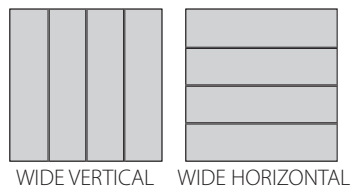

THERMO PREMIUM INSULATED STANDARD SIZES

Both designs are available in the sizes and colours as listed below.

ORDER CODE	OVERALL FRAME SIZE mm*	WHITE	BROWN	GOLDEN OAK / WALNUT	METALLIC BLACK / GRAPHITE
7066	2254 x 2031	£660	£680	£825	£760
7070	2254 x 2190	£665	£685	£835	£765
7666	2406 x 2031	£680	£700	£875	£780
7670	2406 x 2190	£695	£715	£900	£795
8066	2558 x 2031	£715	£735	£930	£815
8070	2558 x 2190	£735	£755	£965	£835



Many garage doors can be draughty with large gaps and no seals. Our Thermo Premium door not only has seals but is insulated too, keeping warmth in and the weather out!



TIMBER STANDARD SIZES

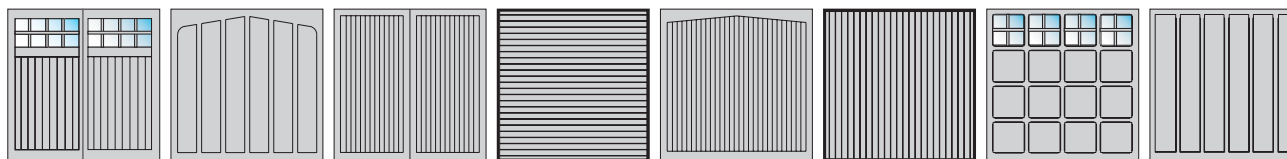

ORDER CODE	OVERALL FRAME SIZE*	BAMBURGH	FAIRBOURNE	HIGHCLERE	MERIDEN	SHERINGHAM	TEWKSBURY	ULLSWATER	WHITWELL
7066	2254 x 2031	£1,550	£1,045	£1,375	£1,255	£1,305	£1,215	£1,470	£1,185
7070	2254 x 2190	£1,575	£1,090	£1,385	£1,260	£1,335	£1,230	£1,510	£1,215
7666	2410 x 2031	£1,635	£1,220	£1,435	£1,275	£1,400	£1,245	£1,695	£1,220
7670	2410 x 2190	£1,665	£1,245	£1,455	£1,300	£1,410	£1,300	£1,725	£1,245
8066	2560 x 2031	£1,655	£1,300	£1,475	£1,320	£1,435	£1,320	£1,855	£1,300
8070	2560 x 2190	£1,695	£1,335	£1,495	£1,325	£1,470	£1,325	£1,885	£1,335
9066	2870 x 2031	£1,900	£1,620	£1,855	£1,745	£1,745	£1,745	£2,165	£1,620
9070	2870 x 2190	£1,940	£1,655	£1,875	£1,790	£1,770	£1,790	£2,185	£1,655

COLOURS

Doors are supplied basecoat treated ready for staining or fully finished with the supplement shown below. When fittings doors side by side please advise - a sympathetically matched pair will be selected.

	Doors up to 8'0" wide	Doors over 8'0" wide
Light Oak, Antique Oak, Chestnut, Mahogany, Walnut, Ebony	£115	£195
Silver Grey	£175	£225

*Frame sizes do not include any fitting tolerances - this must be allowed for if required.



LEGBUD UK, Unit 19, The Fort Industrial Park,
Dunlop Way, Birmingham B35 7AR

Tel: 0121 749 3699
Fax: 0121 748 2677
e-mail: sales@legbud.co.uk
web: www.legbud.co.uk

Technical

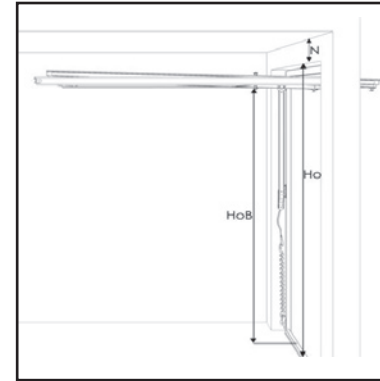
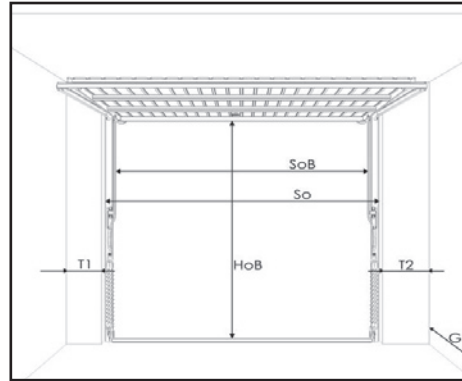

Framed Retractable Doors all sizes

Frame size	60mm per side and 50mm cross bar.
SOB =	Door size less 38mm per side.
SO =	Door and frame size combined.
T1 / T2	Side room - only Important if frame is fitted behind the brickwork when 100mm per side is required (frame + Brackets).
G =	7ft high door 1.950m (from back of Frame) 6'6" high 1.850m (From back of frame) (manual operation).
Threshold strip	32mm high.
Wicket door	900mm walk through.
Ho =	Door height plus 60mm frame.
HOB =	Frame opening height less 100mm.
N =	N/A
Kick out -	Refers to the out swing of the door - maximum 1200mm.

All sizes exclude fitting tolerances and these should be assessed on site depending on the application, a recommendation is 8-10mm per side.

If the threshold is removed we strongly recommend the fitting of a bottom brush seal to the bottom of the door.

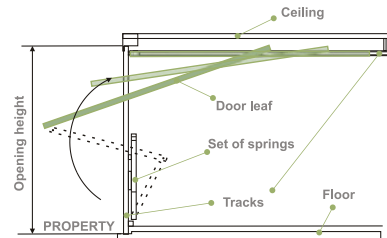

Product Guarantees

Legbud Gargula manufactures products to the highest standards and your garage door only leaves our factory after a thorough quality and testing process.

In the unlikely event of a warranty claim, please contact your dealer that installed your garage door, and supply them details of the barcode on the side of the door. Your dealer will supply further details of your claim with proof of purchase, to the Warranty Department at LEGBUD UK.

1. Warranty Period.

A warranty covering the safe and reliable operation of the LEGBUD garage door for a period of 10 years from the date of purchase is given to the original purchaser.

The purchaser is given a 2 year warranty for all springs; tracks; rollers; and hinges for normal use, whereby normal use constitutes no more than 5 operations (open/close) per day. We recommend that they are inspected annually by a competent engineer. The warranty period for replacement parts is 6 months or for the remainder of the warranty period.

2. Requirements.

Warranty is valid in the country where the garage door was purchased. The product must have been purchased through one of our authorised partners and a barcode and receipt of purchase provided. The warranty only covers damage to the garage door.

3. Performance.

During the warranty period we will rectify defects to the Legbud product that can be proved to be material or manufacturing faults. At our discretion we will either exchange; repair; or reduce the price. We will not accept any costs for dismantling; installation; or delivery.

The warranty does not cover damage caused by:

- Improper transport and fitting.
- Repairs by non-qualified or non competent individuals.
- External influences such as fire, water, alkaline solutions, acid, bird droppings or abnormal atmospheric pollution.
- The use of non Legbud parts without the approval of the manufacturer.

Additional Information:

- It is a fundamental condition of this guarantee that the product has been installed, maintained and serviced correctly and is used solely for the purpose for which it was designed.
- Incorrect installation, maintenance and service will invalidate this warranty.
- The door must be kept in a clean condition and free from impact damage.

garage doors
classic style
INTELLIGENT DESIGN

Presented by: